

# PROTECTION SCREEN

## 防护屏

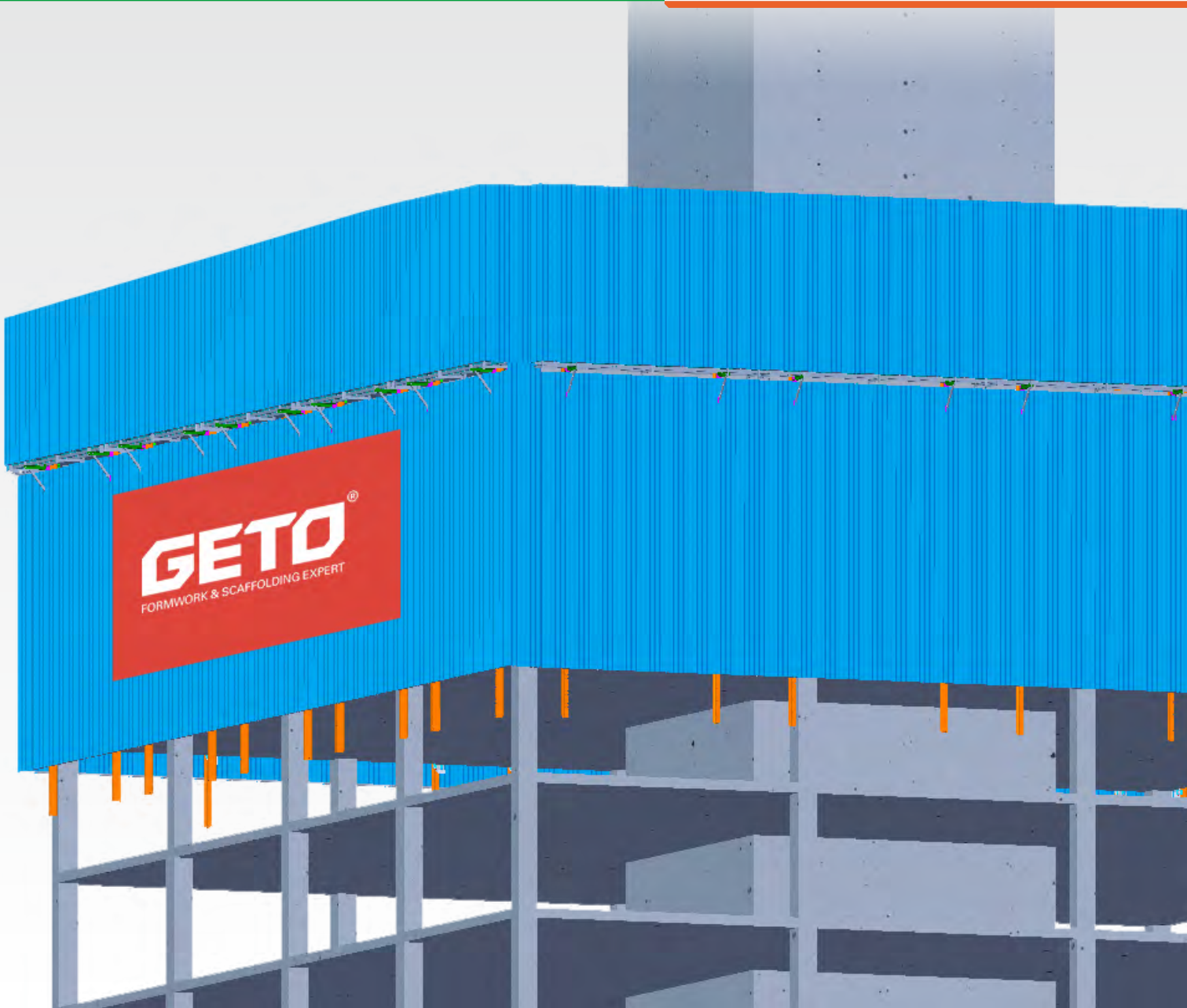

An aerial photograph of a modern city skyline. The central focus is a tall, glass-clad skyscraper with the 'GETO' logo on its upper section. The building is surrounded by other modern high-rise buildings, green spaces, and a river. A large green semi-transparent box is overlaid on the right side of the image, containing text in English and Chinese.

# COMPANY PROFILE

## 公司简介

GETO is mainly engaged in Green Construction and New Energy.

Green construction includes formwork and prefabricated construction, specifically aluminium formwork, climbing system, steel formwork, steel-framed timber formwork, fair-faced concrete building, assembly precast concrete components, PPVC/ MIC precast housing molds and prefabricated steel structure.

The main focus of new energy is investment, construction, and operation of "Photovoltaics, Storage, and Charging" projects.

GETO was listed on the ChiNext board of the A-share market in 2021, and currently has established 12 production bases around the world, registered 31 international trademarks in different countries and regions. Our products and services have sold well worldwide.

志特集团主营绿色建筑和新能源两大板块。

绿色建筑包括模架及装配式建筑，即铝模，爬升式模架，钢模板体系，钢框木模，清水混凝土特色建筑，装配式建筑 PC、整屋装配式 PPVC/MIC，装配式钢结构。

新能源主营“光、储、充”项目投资、建设、运维。

“志特新材”于 2021 年在 A 股创业板挂牌上市，目前已在全球设立 12 大生产基地，在 31 个国家和地区注册了“GETO®”国际商标，产品和服务遍及全球。

# CONTENTS

## 目录

### 01/ P06

#### PROTECTION SCREEN INTRODUCTION 防护屏介绍

Protection Screen Profile  
防护屏简介

Application  
应用场景

Features and Advantages  
特点和优势

### 02/ P14

#### PROTECTION SCREEN SYSTEM 防护屏系统

Protection Screen for Commercial Building  
公建防护屏

Protection Screen for Residential Building  
住宅防护屏

Components  
产品构件组成

Technical Parameters  
产品技术参数

### 03/ P22

#### PRINCIPLES AND PROCESS OF CLIMBING 爬升原理与流程

Principles of Climbing  
爬升原理

Process of Climbing  
爬升流程

### 04/ P28

#### TECHNICAL SOLUTIONS 特殊位置处理方式

Tower Crane Attached Arm  
塔吊附臂

Elevator  
电梯

Loading Platform  
卸料平台

Bay Window Attachment  
飘窗附着

Floor Attachment  
板面附着

Floor Elevated Attachment  
板面垫高附着

Structure Overhead Attachment  
架空位置附着

Attached Hoop for Steel Column  
钢结构柱子抱箍附着

Cantilever Reinforcement at the Top of the Frame  
架体顶部悬臂加固

Attachment of the Inclined Facade  
倾斜外立面附着

# PROTECTION SCREEN INTRODUCTION

## 防护屏介绍

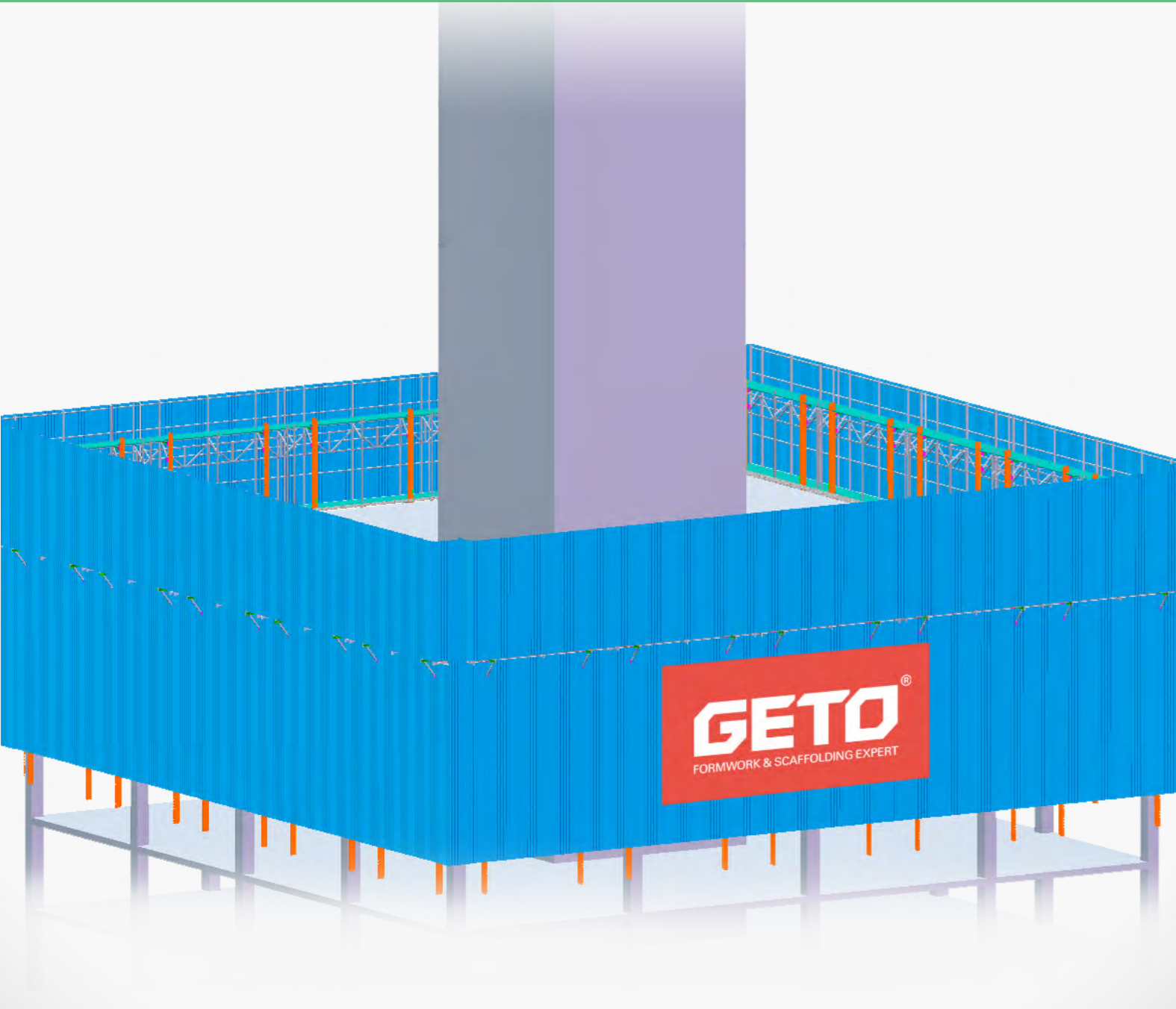

## PROTECTION SCREEN PROFILE

### 防护屏简介

Protection screen is an innovative safety device attached to structures (floors, beams, or walls) and lifted using a tower crane or hydraulic system. Specifically designed to fulfill peripheral protection needs for high-rise and super-high-rise buildings.

There are obvious differences between the facade walls of commercial and residential buildings. Residential buildings typically have many facades, demanding protection screens for exterior work, while commercial buildings' fewer facades permit work from internal edges.

Therefore, GETO protection screens are categorized into residential protection screens with more platform layers, and commercial building protection screens with fewer platform layers.

防护屏是一种附着在结构上（楼板、梁或墙体），通过塔吊或液压系统进行提升的新型安全防护装置。主要用于高层、超高层建筑结构的外围施工防护。

公共建筑与住宅楼的外立面墙体存在明显区别。常见的住宅楼外立面墙体较多，对外墙施工的人员需防护屏提供作业区域以供站立；常见的公共建筑外立面墙体极少，对建筑边缘施工的人员可以站在建筑内部。

因此志特防护屏分为住宅防护屏和公建防护屏，住宅防护屏的平台板层数较多，公建防护屏的平台板层数较少。

Protection Screen for Commercial Building  
公建防护屏

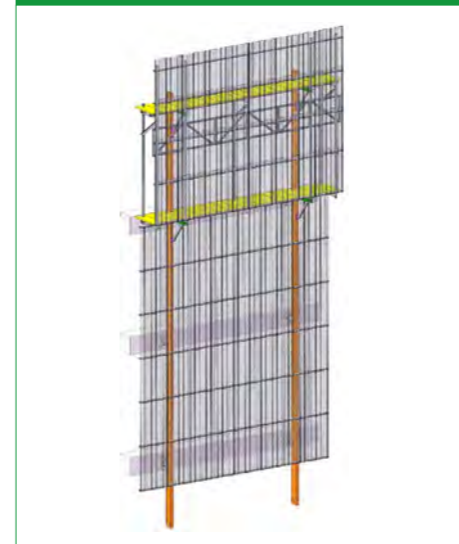

Protection Screen for Residential Building  
住宅防护屏

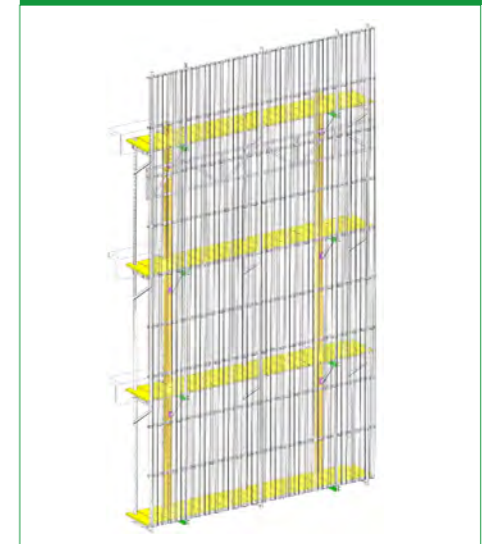

# Application 应用场景



Comprehensive Building 综合性建筑



Condominium 公寓式大厦

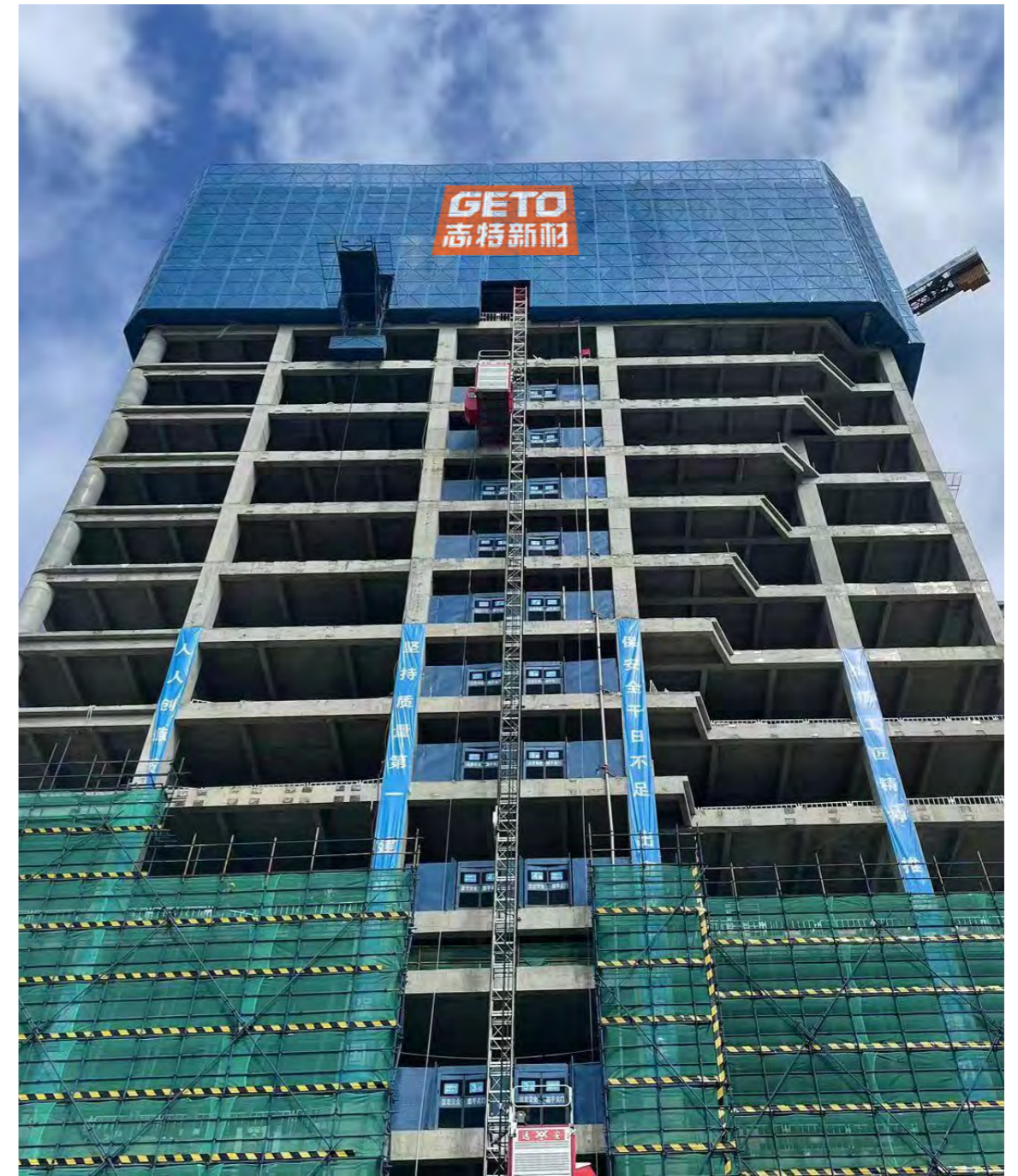

Office Building 办公楼

# Features and Advantages 特点与优势

## -Features 特点

1. Guide rails and platform boards are 0.3m from the wall for easy installation of beam and wall formwork.

导轨和平台板与墙面净距为 0.3m，便于梁、墙模板支设。

2. Seal flaps can be installed as needed.

可以按需设密封翻板。

## -Advantages 优势

### 1. High safety

安全性高

#### ·High wind resistance 高抗风性

Capable of withstanding a maximum wind load of 9 levels without extra reinforcement.

Additional reinforcement is needed for wind loads beyond level 9.

可承受最大 9 级的风荷载，无需额外加固。超过 9 级的风荷载，需要额外加固。

**Case:** Designed with consideration for various regional climates, our protection screen assure normal operation in most weather conditions and safety in extremes. In the implementation of the protection screen project in the Kuala Lumpur, Malaysia, historical wind speed data from 2012 to 2023 was analyzed. It was found that only on December 12, 2015, did the wind speed exceed 83.5 kilometers per hour (Level 9). In most other years, extreme wind speeds did not surpass 80 kilometers per hour. In this region, ensuring safety against wind speeds of level 9.

**案例：**我们会根据不同地区气候特点进行针对性设计，以确保防护屏可以在绝大多数天气正常使用，并确保在极端天气情况下的安全性。以吉隆坡地区实施防护屏项目为例，查询马来西亚吉隆坡地区 2012-2023 年的历史风速数据，仅在 2015 年 12 月 12 日风速超过 83.5 公里 / 小时（9 级）。在大多数其他年份，极端风速不超过 80 公里 / 小时，在此地区，按 9 级风计算，确保安全。

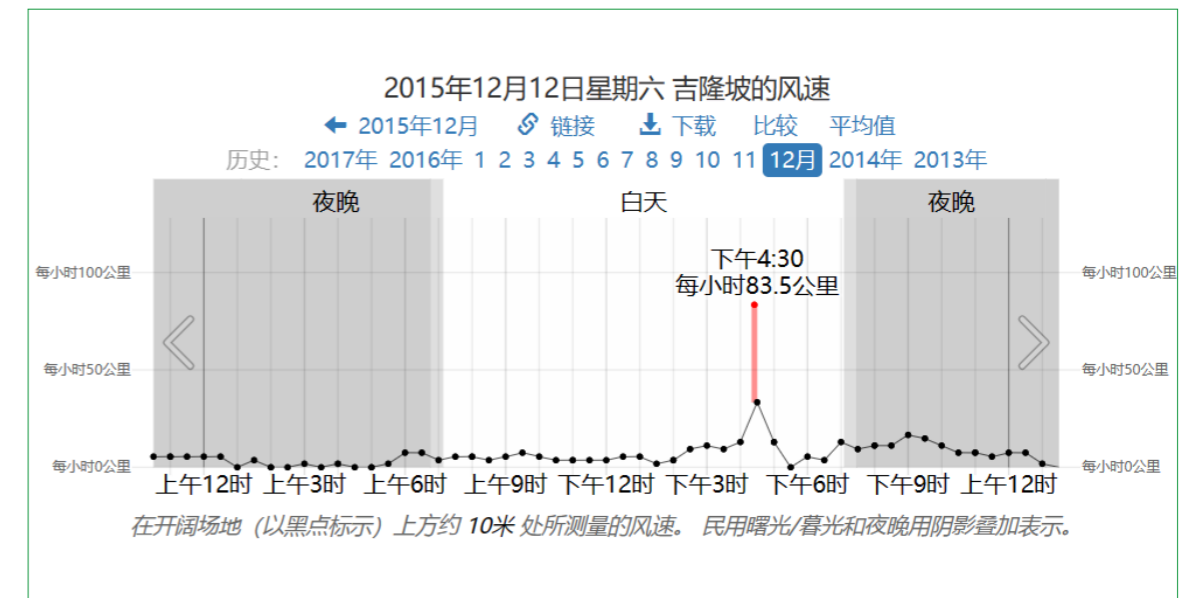
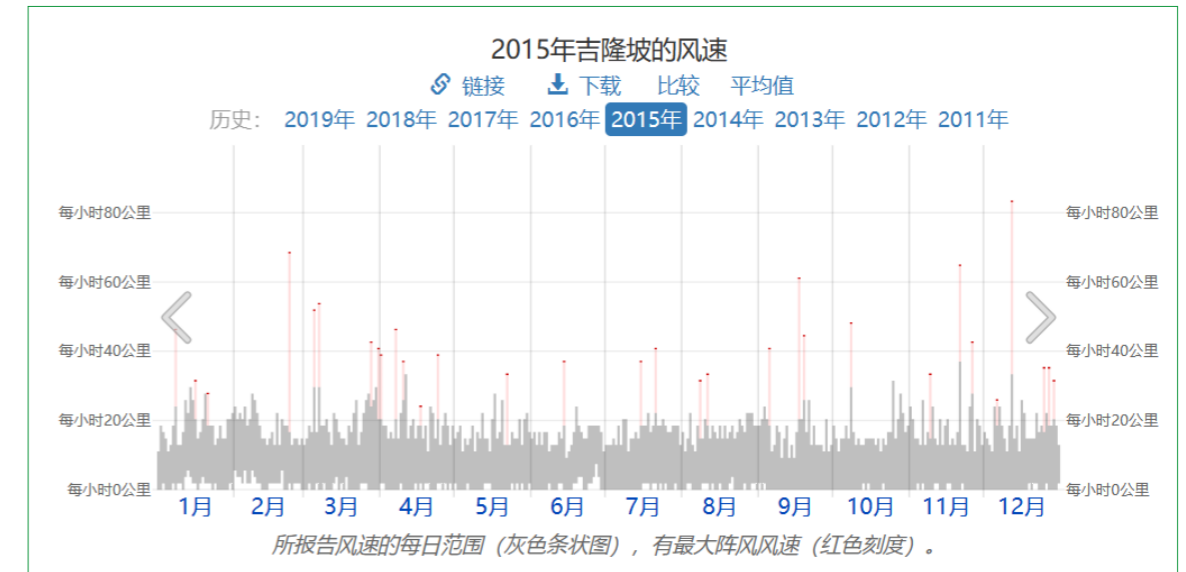

· Fall arrest 高竖向荷载承载力，防坠落

Fall arrest devices attached during climbing are independent, minimizing safety issues resulting from operational errors.

爬升附着的防坠装置相互独立，最大限度地减少因操作错误而导致的安全问题。

Protection against personnel and items being dropped is ensured by full sealing, including guide rails, corners, and protruding parts.

所有部件采用完全密封设计，包括导轨、拐角和突出部分，防止人员和物品掉落。

All components undergo rigorous testing, including extreme loads and falls, to ensure safety in extreme conditions.

所有部件都经过严格的测试，包括极限载荷和坠落测试，以确保极端情况的安全性。



2. Higher productivity and cost efficient

经济适用性强

- Strong universality of components for easy management.  
构件通用性强，便于管理。

Main components do not exceed 10 types, achieving a universal compatibility rate of 95% or higher.

主要组件不超过 10 种类型，且可达到 95% 或更高的通用兼容率。

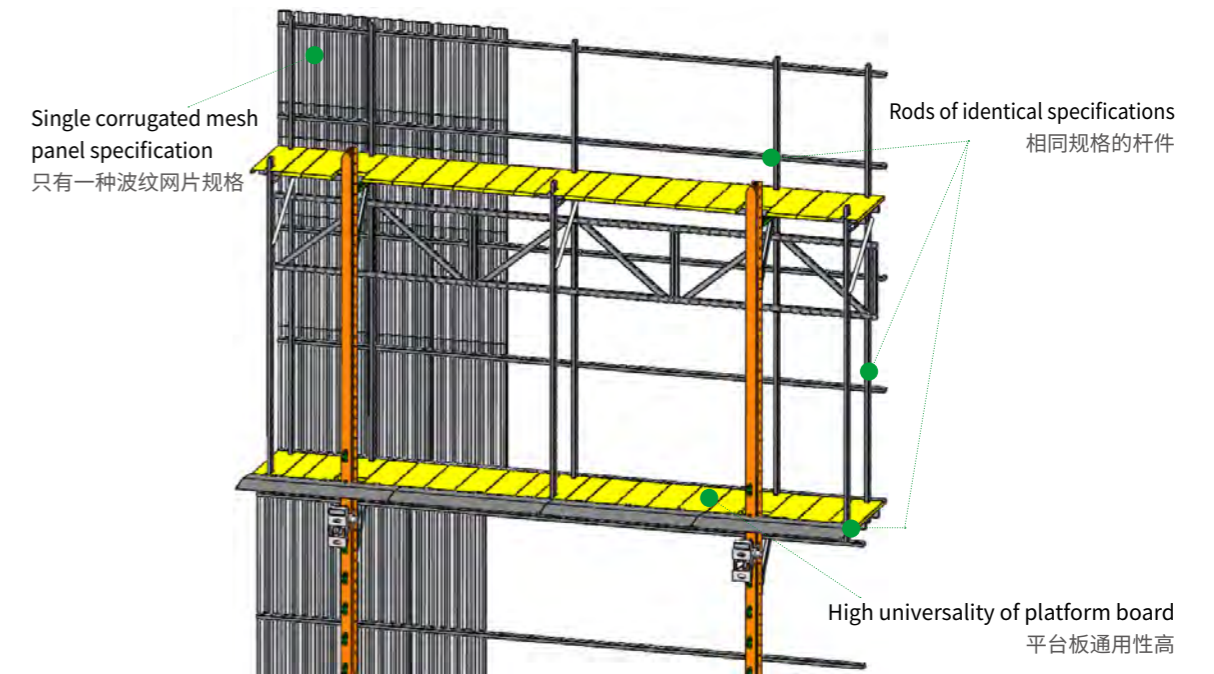

- Hydraulic drive system  
液压驱动装置

Compared to conventional protection platform using electric hoists and electronically controlled, the cost is lower.

与常规爬架采用电葫芦和电控相比，投入更低。

- Reliable, maintainable, and easy to operate.  
爬升操作简单，动力装置可靠性高，日常维护保养方便。

- Lower costs for disassembly, transportation, and labor due to the lightweight frame compared to regular steel climbing platforms.

与常规全钢爬架相比，架体重量轻，拆装、运输、劳务成本低。

3. Multi-functional

多功能

- Suitable for diverse shapes and heights of structure. Adjustable floor supports permit use on facades with both varying and constant inclinations.

可以适用多种结构造型的结构楼，可实现标准立面、外倾立面、内倾立面等多种角度爬升。

- Platform boards and sealed flaps can align with floor levels.

平台板和密封翻板可平齐楼层位置。

# PROTECTION SCREEN SYSTEM

## 防护屏系统



## Protection Screen for Commercial Building

### 公建防护屏

Protection screen for commercial building consists of climbing system, vertical main framework, structure of scaffold body and protection and sealing.

公建防护屏由爬升系统，竖向主框架，架体构架，防护和密封四个部分组成。

Suitable for the peripheral protection requirements of high-rise and super-high-rise office buildings.

公建防护屏主要适用于高层、超高层写字楼的外围施工防护。

PROTECTION SCREEN SYSTEM  
防护屏系统 02

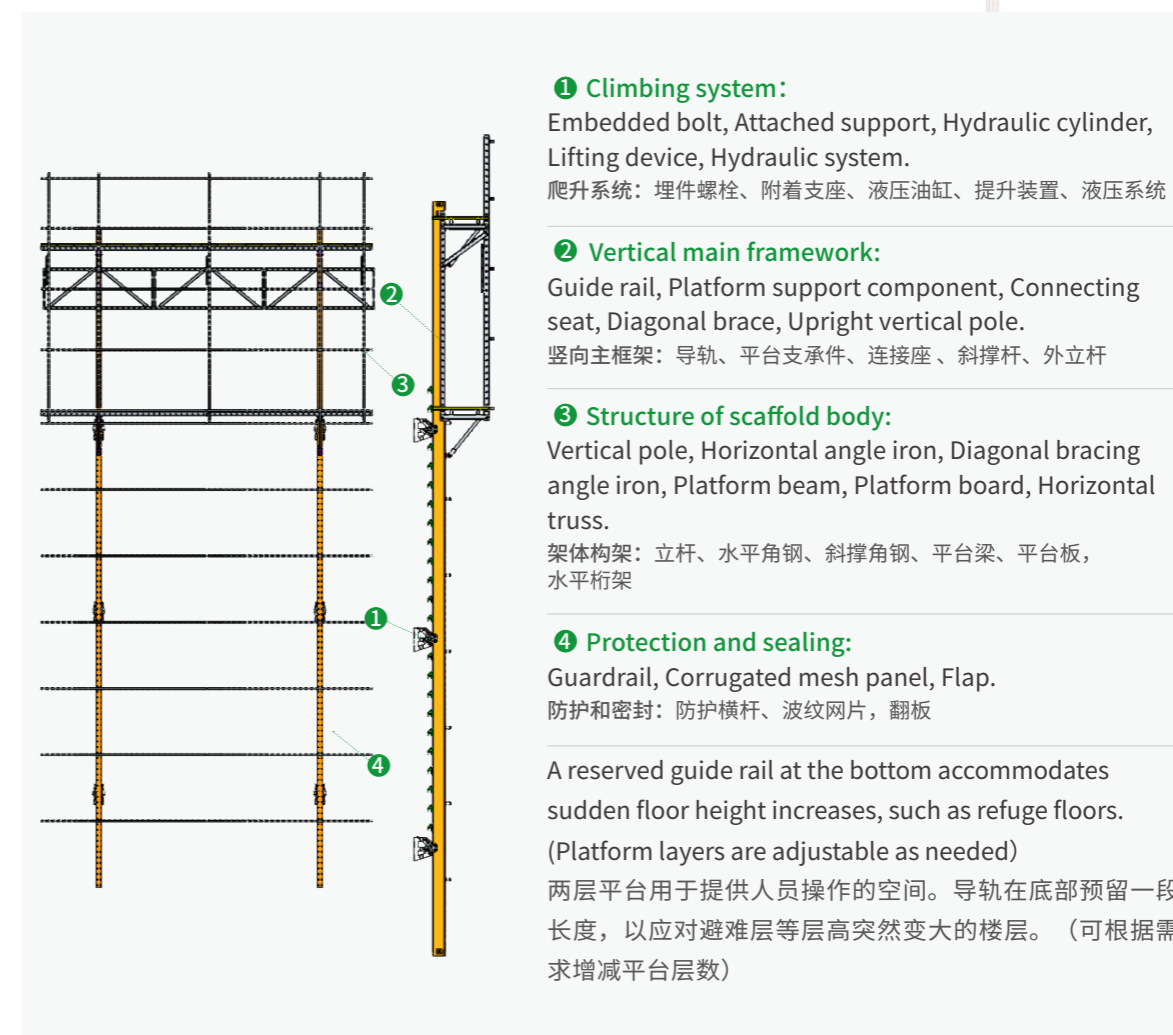
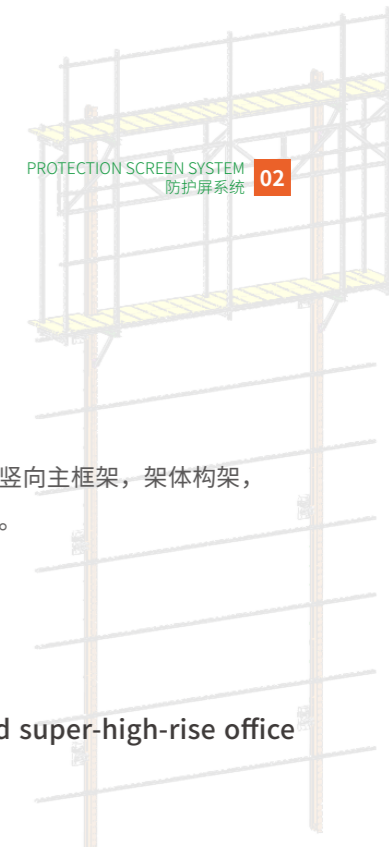



# Protection Screen for Residential Building 住宅防护屏

Protection screen for residential building consists of climbing system, vertical main framework, structure of scaffold body and protection and sealing.

住宅防护屏由爬升系统，竖向主框架，架体构架，防护和密封四个部分组成。

Suitable for the peripheral protection requirements of high-rise and super-high-rise residential buildings.

住宅防护屏主要适用于高层、超高层住宅楼的外围施工防护。

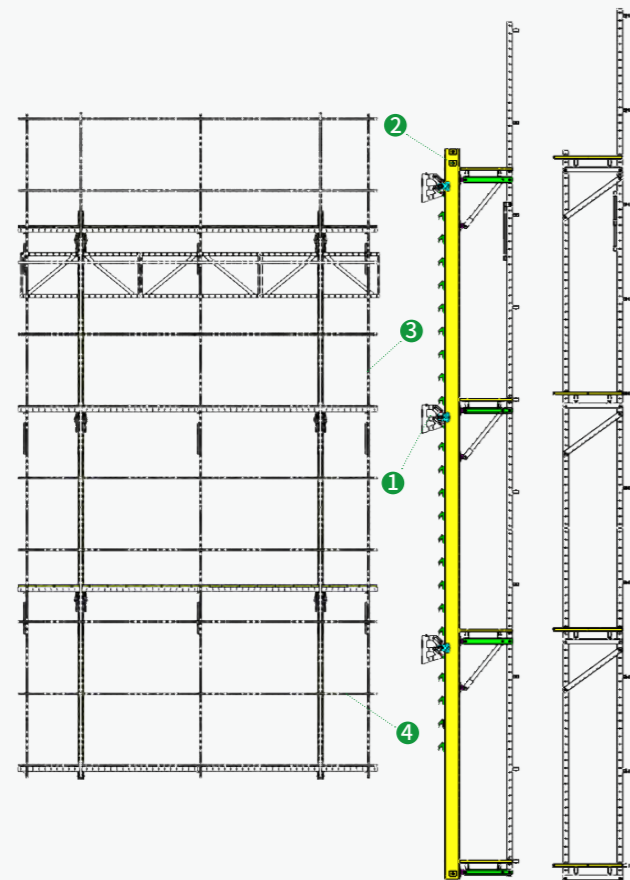

### 1 Climbing system:

Embedded bolt, Attached support, Hydraulic cylinder, Lifting device, Hydraulic system.  
爬升系统：埋件螺栓、附着支座、液压油缸、提升装置、液压系统

### 2 Vertical main framework:

Guide rail, Platform support component, Connecting seat, Diagonal brace, Upright vertical pole.  
竖向主框架：导轨、平台支承件、连接座、斜撑杆、外立杆

### 3 Structure of scaffold body:

Vertical pole, Horizontal angle iron, Diagonal bracing angle iron, Platform beam, Platform board, Horizontal truss.  
架体构架：立杆、水平角钢、斜撑角钢、平台梁、平台板，水平桁架

### 4 Protection and sealing:

Guardrail, Corrugated mesh panel, Flap.  
防护和密封：防护横杆、波纹网片，翻板

Multiple platform levels aligned with building floors for convenient construction.  
具有多层平台，并与建筑楼层平齐，便于施工。

# Product Components 产品构件组成

## -Climbing system 爬升系统

Embedded bolt, Attached support, Hydraulic cylinder, Lifting device, Hydraulic system  
埋件螺栓、附着支座、液压油缸、提升装置、液压系统

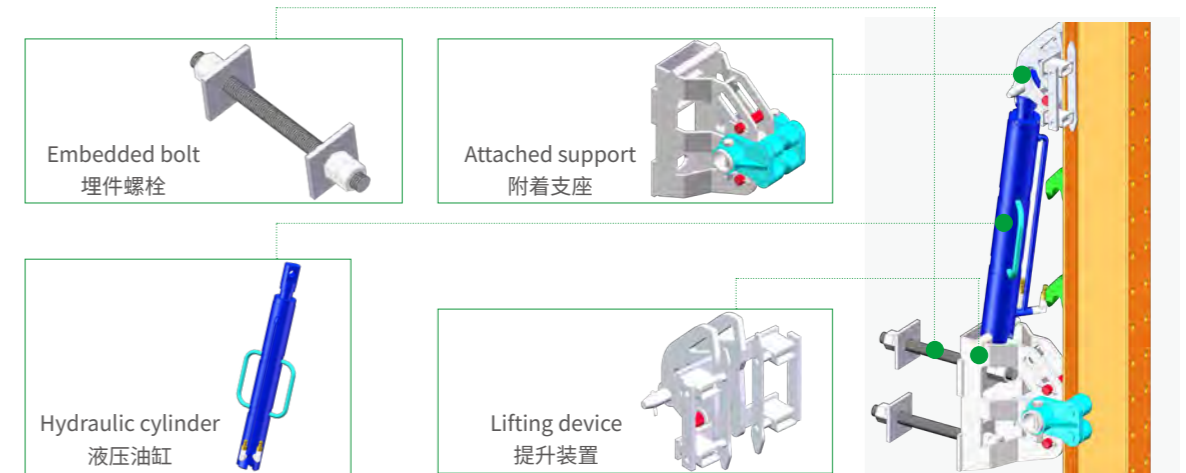

## Hydraulic system 液压系统

The hydraulic system consists of a pump station (power device), hydraulic oil circuit, and other components. It can circulate for use in multiple sets of protection screen units.  
Hydraulic system configuration: One pump station drives four hydraulic cylinders, each with an inlet and an outlet hydraulic pipelines.

液压系统由泵站（动力单元）、液压油路等组成。一套液压系统可周转应用于多套防护屏单元的爬升。  
液压系统的配置：最大1拖4。1个泵站驱动4个液压油缸，每个液压油缸有一进一出两个油路管道。

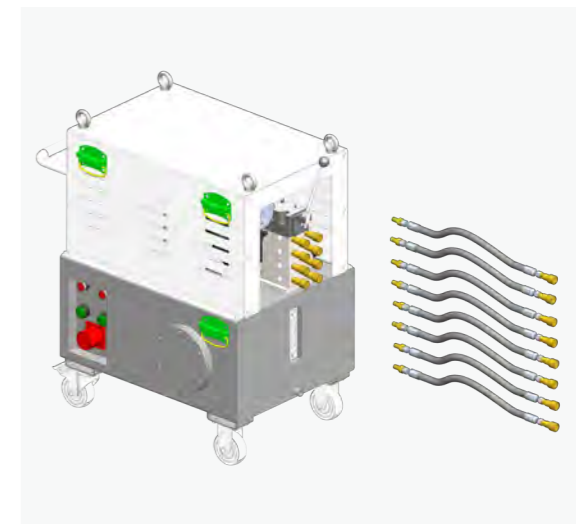

## -Vertical main framework 竖向主框架

Guide rail, Platform support component, Connecting seat, Diagonal brace, Upright vertical pole.

导轨、平台支承件、连接座、斜撑杆、外立杆

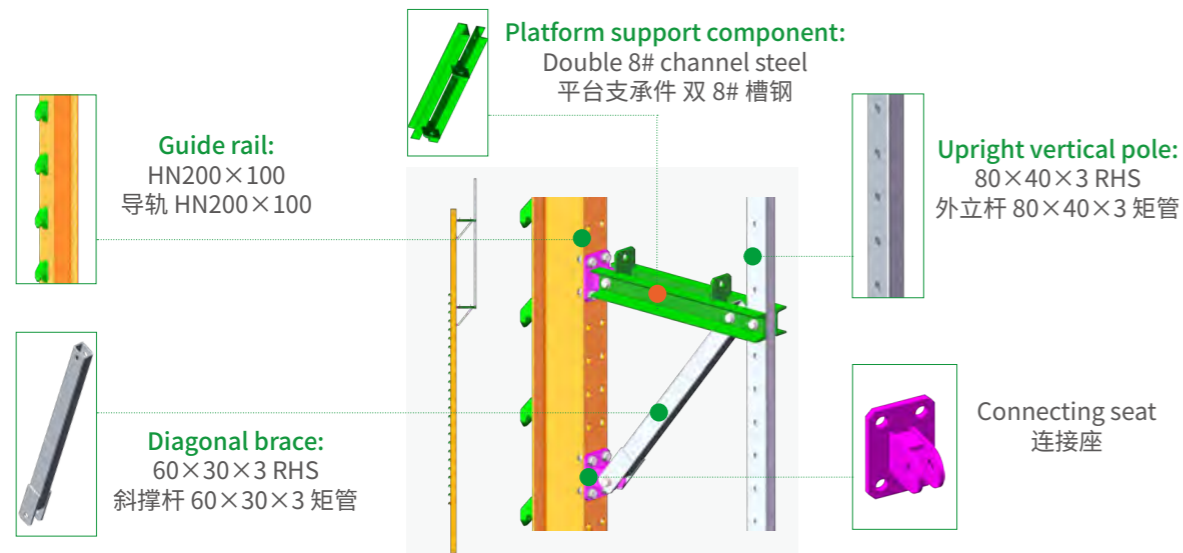

## -Structure of scaffold body 架体构架

Vertical pole, Horizontal angle iron, Diagonal bracing angle iron, Platform beams, Platform board, Horizontal truss.

立杆、水平角钢、斜撑角钢、平台梁、平台板、水平桁架

① **Horizontal truss:** 60×40×3 RHS 40×40×3 SHS  
水平桁架：60×40×3 矩管、40×40×3 方管

② **Vertical pole:** 80×40×3 RHS  
立杆：80×40×3 矩管

③ **Horizontal angle iron:** 63×40×4 angle iron  
水平角钢：63×40×4 角钢

④ **Diagonal bracing angle iron:** 63×40×4 angle iron  
斜撑角钢：63×40×4 角钢

⑤ **Platform board:** 2mm Bended patterned steel plate  
平台板：2mm 花纹钢板

⑥ **Platform beam:** 80×40×3 RHS  
平台梁：80×40×3 矩管

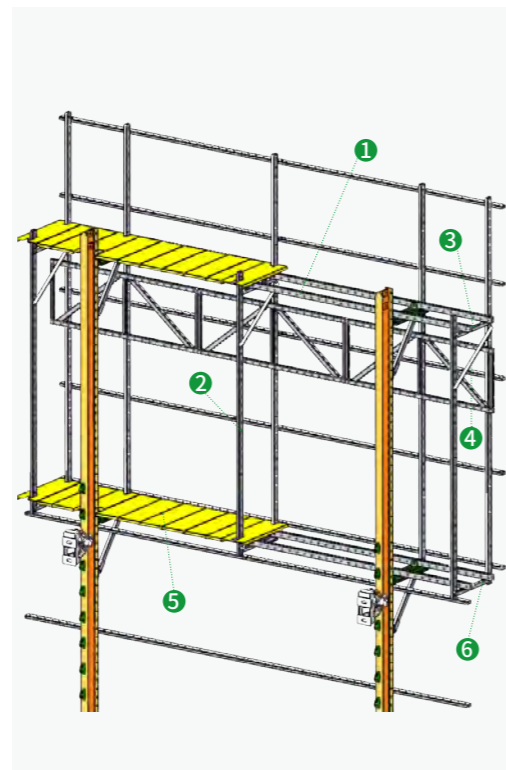

## -Protection and sealing 防护和密封

Guardrail, Corrugated mesh panel, Flap.

防护横杆、波纹网片、翻板

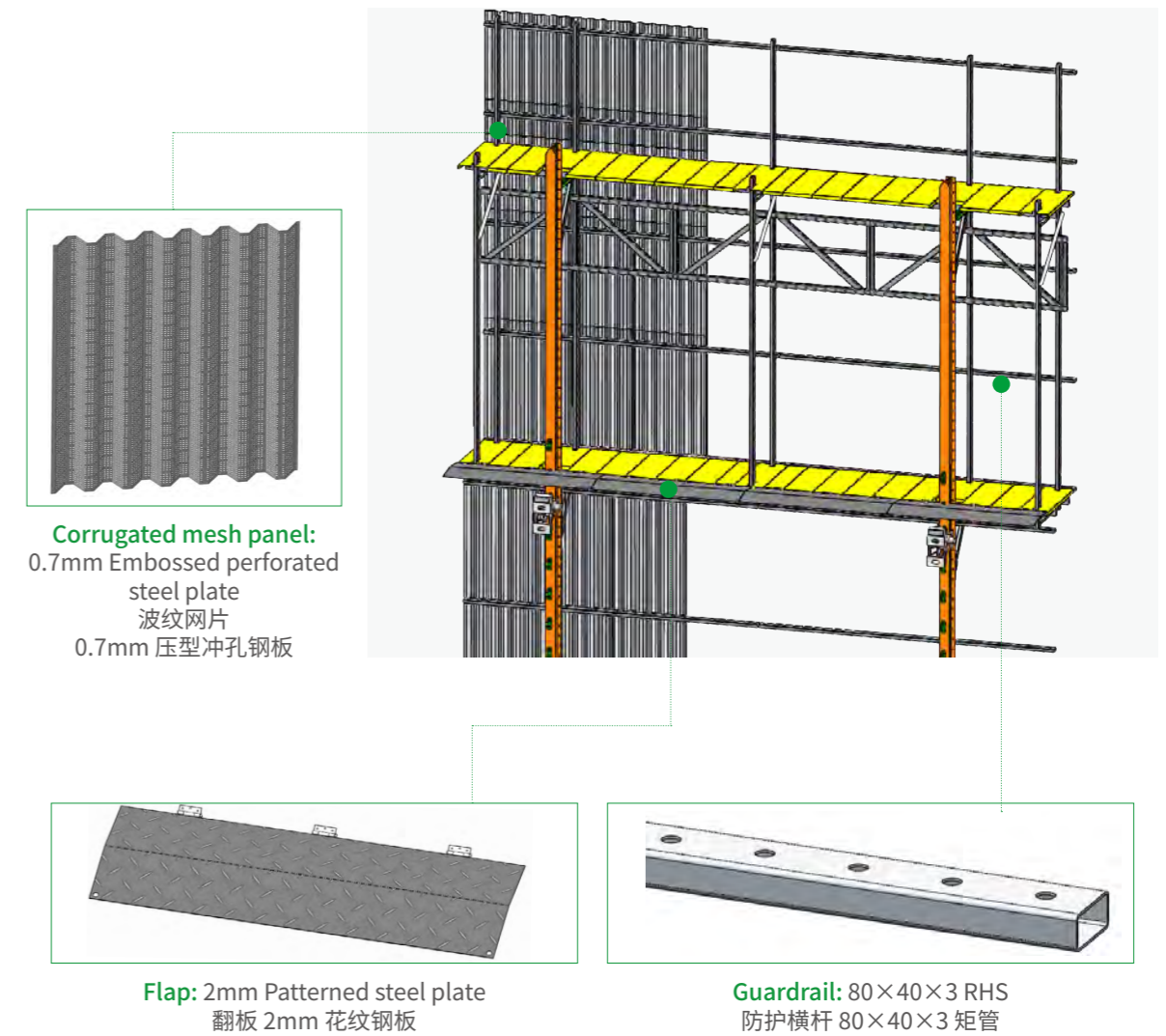

## - Components 零部件

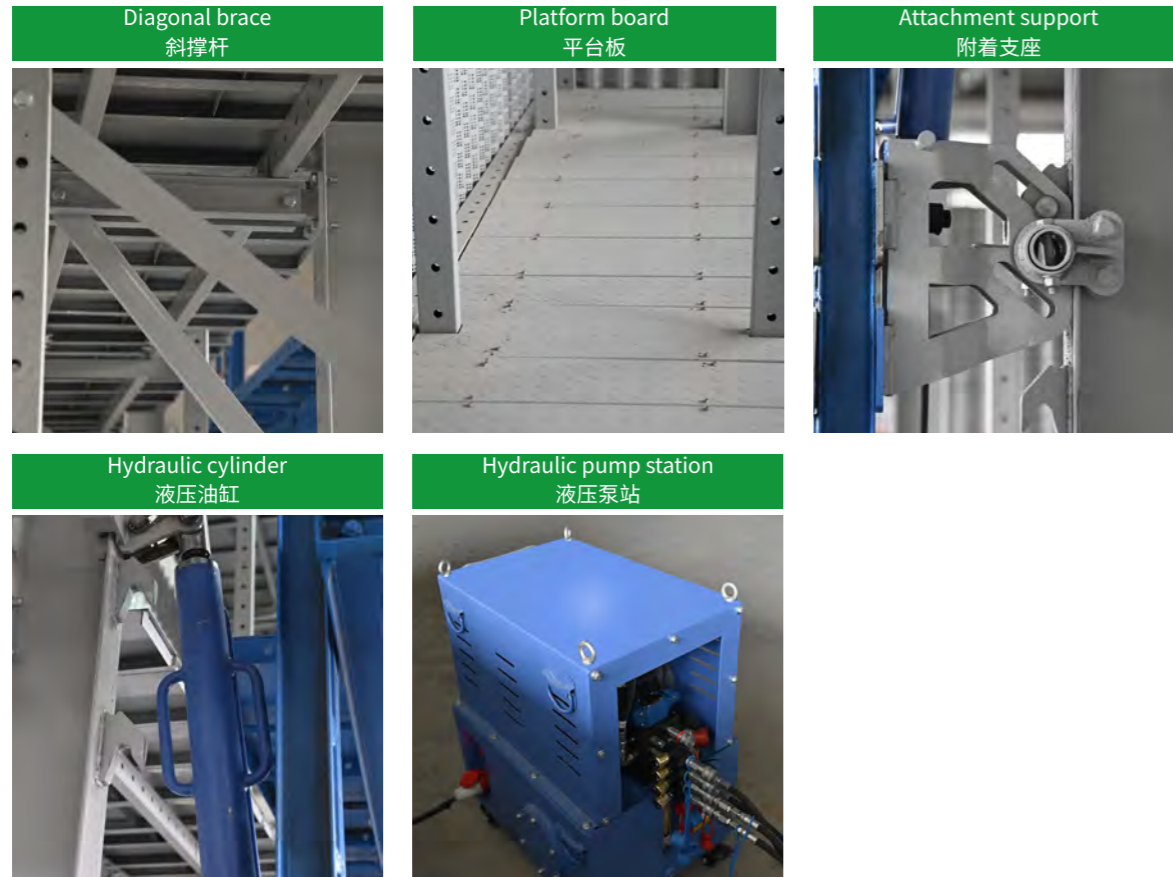

## -Sample Frame 样架

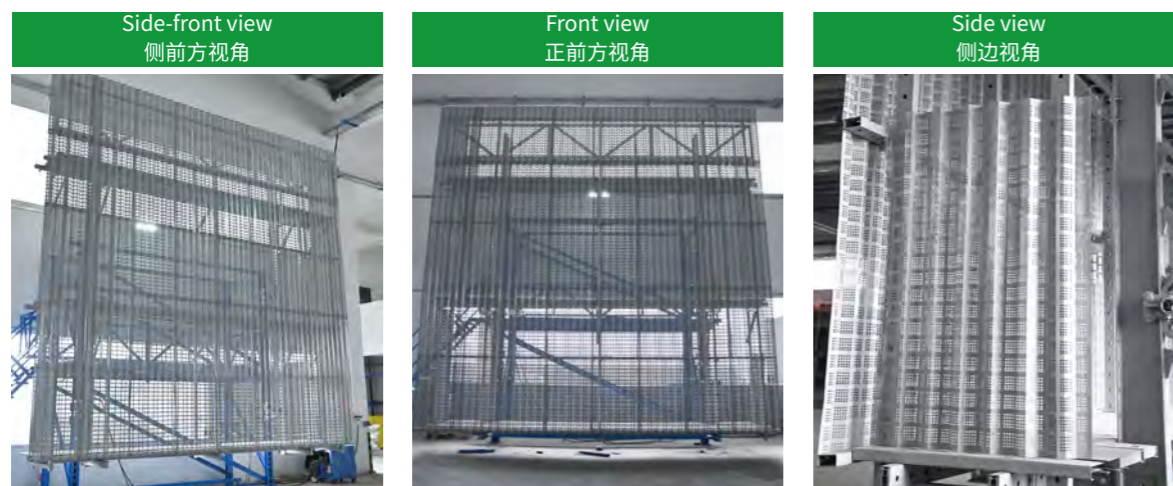

## Surface Treatment of Components 产品构件表面处理工艺

Galvanized surface 表面镀锌

<p><b>Corrosion grade:</b> C5 (Coastal Areas) 腐蚀等级: C5 (沿海地区)</p>	<p><b>Reference standards:</b> GB/T 13912, EN10240 参考标准: GB/T 13912, EN10240</p>	<p><b>Quality inspection standard:</b> Finished galvanization ≥ 85μm, pipe material ≥ 70μm 质检标准: 成 品镀锌 ≥ 85μm, 管材 ≥ 70μm</p>	<p><b>Initial maintenance interval in design:</b> ≥ 10 years. 设计初次维护周期: ≥ 10 年</p>
---	--	--	--

E.g., If a project cycle is 1 year, surface rust prevention can serve for usage and maintenance in at least 10 projects.

例如: 若一个项目周期 1 年, 则表面镀锌可以保持不少于 10 个项目的使用再维护。

## -System Features 产品技术参数

S/N 序号	Item 项目	Unit 单位	Specification 设计值	Remark 备注
1	Framework height 架体高度	m	8~13.5	Adapting framework height to project conditions 根据项目实际情况调整架体高度
2	Framework width 架体宽度	m	0.6-1.2	Standard platform board width: 0.88m 标准平台板宽度为 0.88m
3	Machine position affecting width 机位影响宽度	m	3.5	Total length varies with machine position count 单片机位数不同整片架体长度不同
4	Single unit weight 单机位重量	T	1.3	Calculating based on a 2.5-level protection screen, with a machine position affecting width of 3.5m 按 2.5 层防护屏, 机位影响宽度 3.5m 计算
5	Rated lifting capacity of the power unit 动力装置额定顶升载荷	T	3.5	Hydraulic cylinders, pump station 液压油缸、泵站
6	Power unit capacity 动力装置功率	KW	1.5	Voltage: 380V/415V, Frequency: 50Hz, Max fuse current: 5A (Motor can be customized based on local electrical specifications) 电压 380V/415V, 频率 50Hz, 保险丝最大许可电流 5A (电机可根据项目所在地区用电规格定制)
7	Single lift height of hydraulic cylinder 油缸单次顶升高度	m	0.3	Effective lift height: 0.3m, Total cylinder stroke: 0.42m 有效顶升高度 0.3m, 油缸总行程 0.42m
8	Lifting speed 顶升速度	m/min	0.3	
9	Time for lifting one level 顶升一层时间	min	10	Calculating based on a 3m floor height 按层高 3m 计算
10	Platform load capacity 平台允许载荷	kN/ m <sup>2</sup>	2	Operating on a two-level platform (200kg/m <sup>2</sup> load capacity per level) 按 2 层平台作业 (每层平台每平方米堆载 200kg)

# PRINCIPLES AND PROCESS OF CLIMBING

## 爬升原理与流程



## Principles of climbing

### 爬升原理

#### Initial phase 起始阶段

Installation of hydraulic cylinder and lifting device on attached support.

在附着支座上安装液压油缸和提升装置。

The hydraulic cylinder extends, engaging the guide rail hook, lifting the rail and frame for one cycle. The wall bracket's movable pin supports the hook, and the hydraulic cylinder unloads and retracts.

液压油缸伸长，提升装置的销轴推动导轨挂钩，导轨连同架体整体向上完成一个行程，附墙支座的活动销轴承接挂钩，液压油缸卸荷并收缩。

#### Lifting process 爬升阶段

The hydraulic cylinder repeatedly extends and retracts, gradually lifting the protection screen.

液压油缸反复伸长和收缩，将防护屏一步一步顶升到位。

The hydraulic cylinder retracts, and the lifting device descends to engage the next hook on the guide rail. This repetitive action lifts the protection screen with each cycle.

液压油缸收缩，提升装置下降，直至通过导轨下一个挂钩，然后重复液压油缸的顶升动作，完成第二个行程，如此反复动作，防护屏逐渐上升。

#### Climbing into position 爬升到位

Removing the hydraulic cylinder and lifting device.

移走液压油缸和提升装置。

After lifting the protection screen to the design elevation, remove the hydraulic cylinder after unloading, and install the new layer of wall brackets at the top.

防护屏顶升至设计高程，卸荷之后移走液压油缸，并安装好顶部新一层的附墙支座。



# Process of climbing

## -Main components installation 主要构件安装程序

1. Prepare the site, level the ground, lay foundation blocks, and arrange guide rails as per drawings. Install connecting seat, platform support, and diagonal braces to form the main framework.  
清理好场地后，在平地铺上垫块，按照施工图纸摆放导轨，安装连接座、平台支承件、斜撑杆，组成主框架。
2. Install horizontal truss and upright vertical pole, aligning two main frames with horizontal truss.  
安装水平桁架与外立杆，用水平桁架把两个主框架对齐。
3. Install structure of scaffold body components, including vertical pole, horizontal angle iron, diagonal bracing angle iron, and platform beam.  
安装架体构架杆件，包括立杆、水平角钢、斜撑角钢、平台梁。
4. Install guardrail, platform board, and corrugated mesh panel.  
安装防护横杆、平台板和波纹网片。

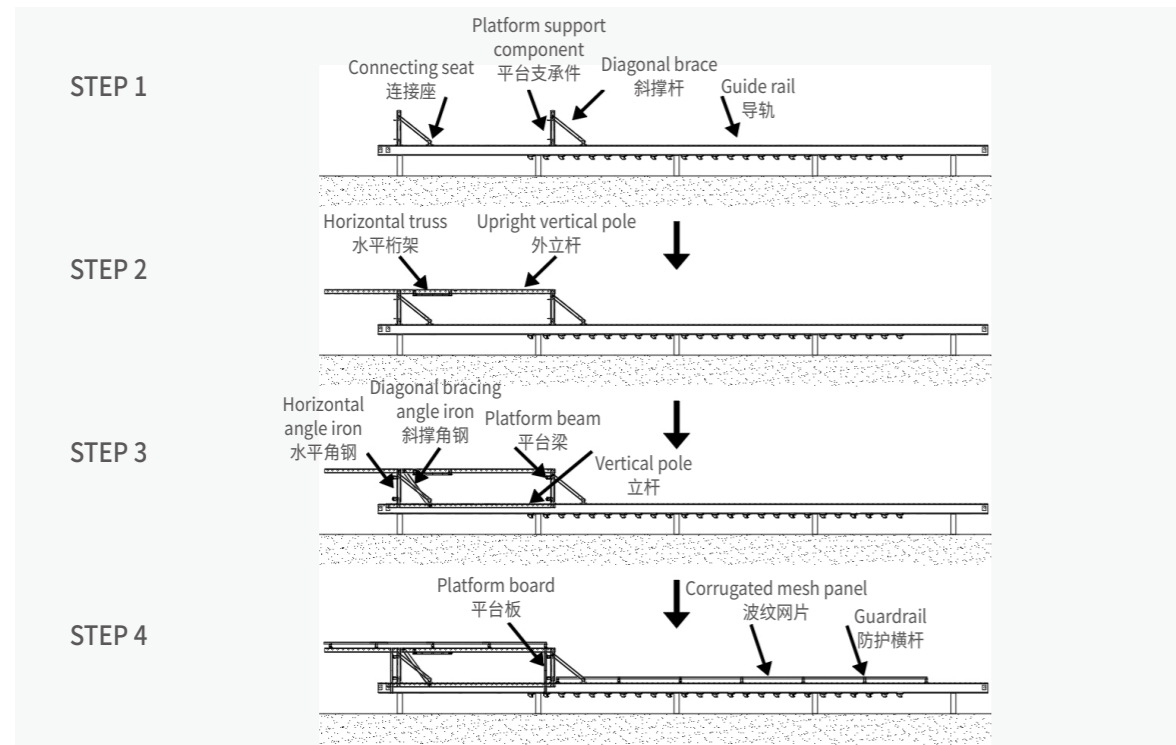

## Installation process 安装阶段

1. Three attaching support are installed for the protection screen.  
As shown, casting for level N+2 is completed.  
防护屏共安装三道附墙装置。  
如图所示，N+2层浇筑完成。
2. Since the protection screen spans 3.5 floors, attaching support need to be installed on the N, N+1, and N+2 floors.  
因防护屏架体覆盖3层半层高，故须安装附墙装置于N、N+1层及N+2层。
3. Hoist the pre-assembled protection screen frame to the predetermined position using a tower crane or autocrane. Hook the protection screen's guide rail onto the load-bearing pin of the two-layer wall bracket.  
使用塔吊或汽车吊将提前在地面组装完成的防护屏架体吊装至预定位置，随后将防护屏导轨钩头钩住两层附墙挂座受力销轴上。
4. After lifting, install and close the flaps, completing the installation of the protection screen.  
吊装完成后安装并闭合翻板，防护屏即安装完成。

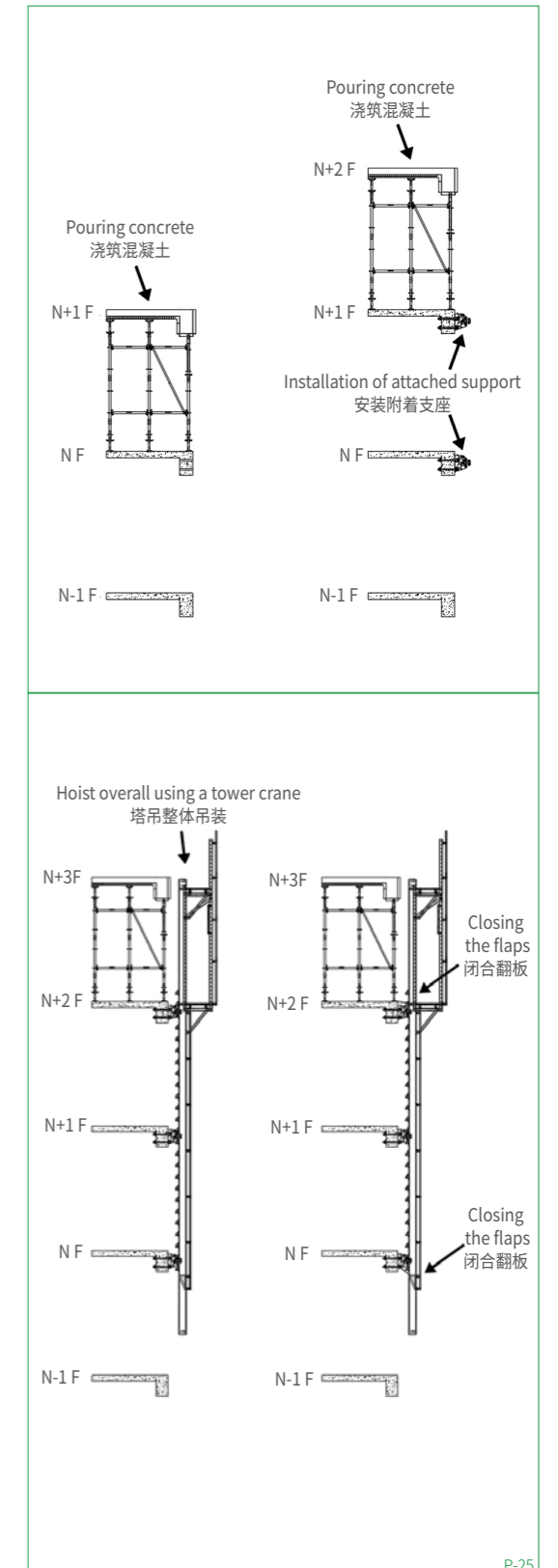

· Lifting process 爬升阶段

1. Before lifting, clear away retaining wall materials, debris, etc.  
爬升准备阶段，清理连墙材料、杂物等。
2. Open the flaps and organize personnel for safety precautions.  
打开翻板，组织人员安全警戒。
3. Power on, start the hydraulic pump station, and engage the hydraulic cylinder to initiate reciprocating lifting.  
接通电源，启动液压泵站带动液压油缸往复爬升。
4. After reaching the predetermined height, hook the guide rail hook onto the wall bracket's load-bearing pin, unload, remove the Hydraulic cylinder, and restore the flaps. Lifting of the protection screen framework is complete.  
爬升到预定高度后，导轨钩头钩挂在附墙挂座受力销轴上并卸荷，拿走液压油缸，并将翻板恢复到位。防护屏架体爬升完毕。

· Dismantling process 拆除阶段

1. After completing construction and form removal, meet conditions for removing protection screen frames and prepare edge protection in advance.  
当结构施工完成最后一部分且拆模后，满足防护屏架体拆除条件，提前准备临边防护措施。
2. Disconnect frame and structure connecting components, then open the flaps.  
断开架体与结构的连接件，打开翻板。
3. When tensioning tower crane wire rope, ensure safety, and remove attached supports and through-wall bolts near the edge.  
当塔吊钢丝绳受力后，拆除人员做好安全措施，临边拆除附着支座及穿墙螺栓。
4. After the removal of protection screen material, enhance edge protection.  
在防护屏材料拆除完毕后，完善临边防护。

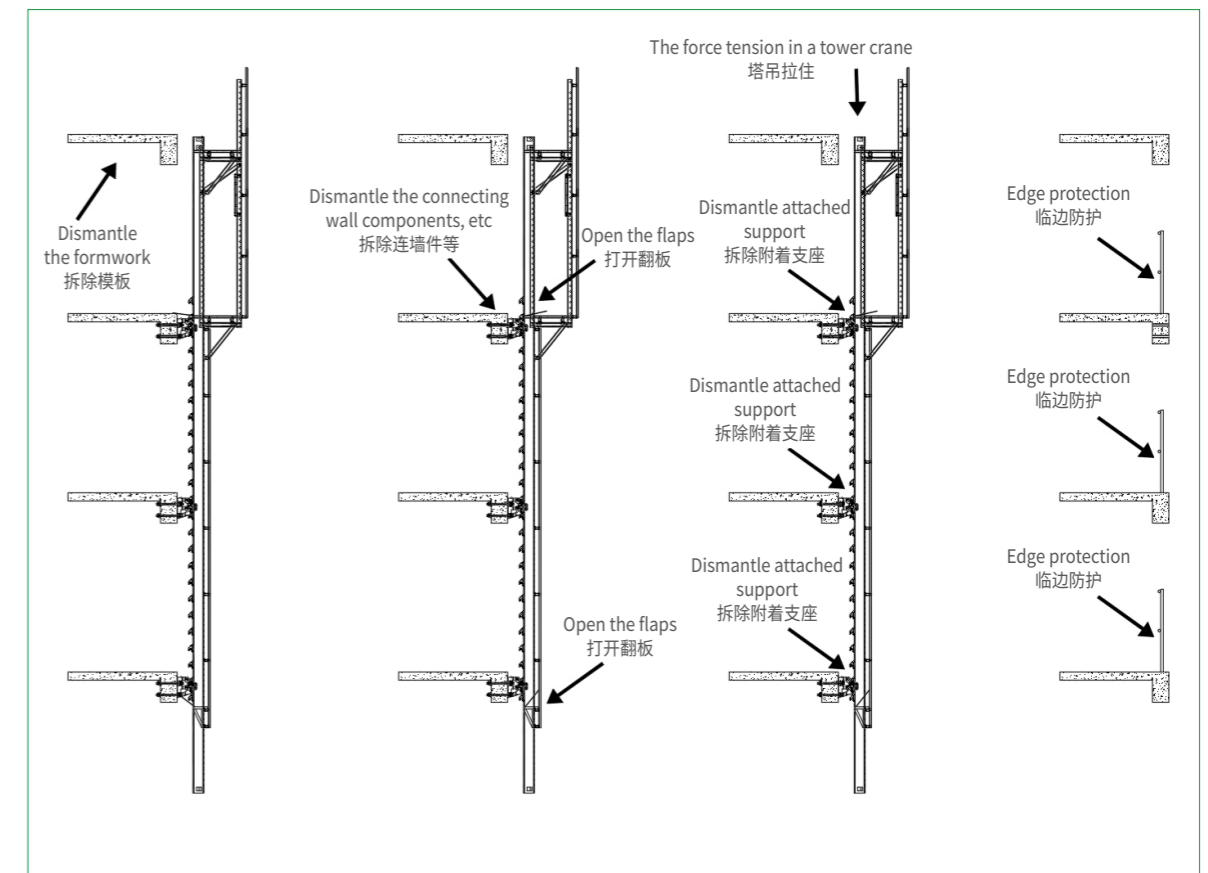
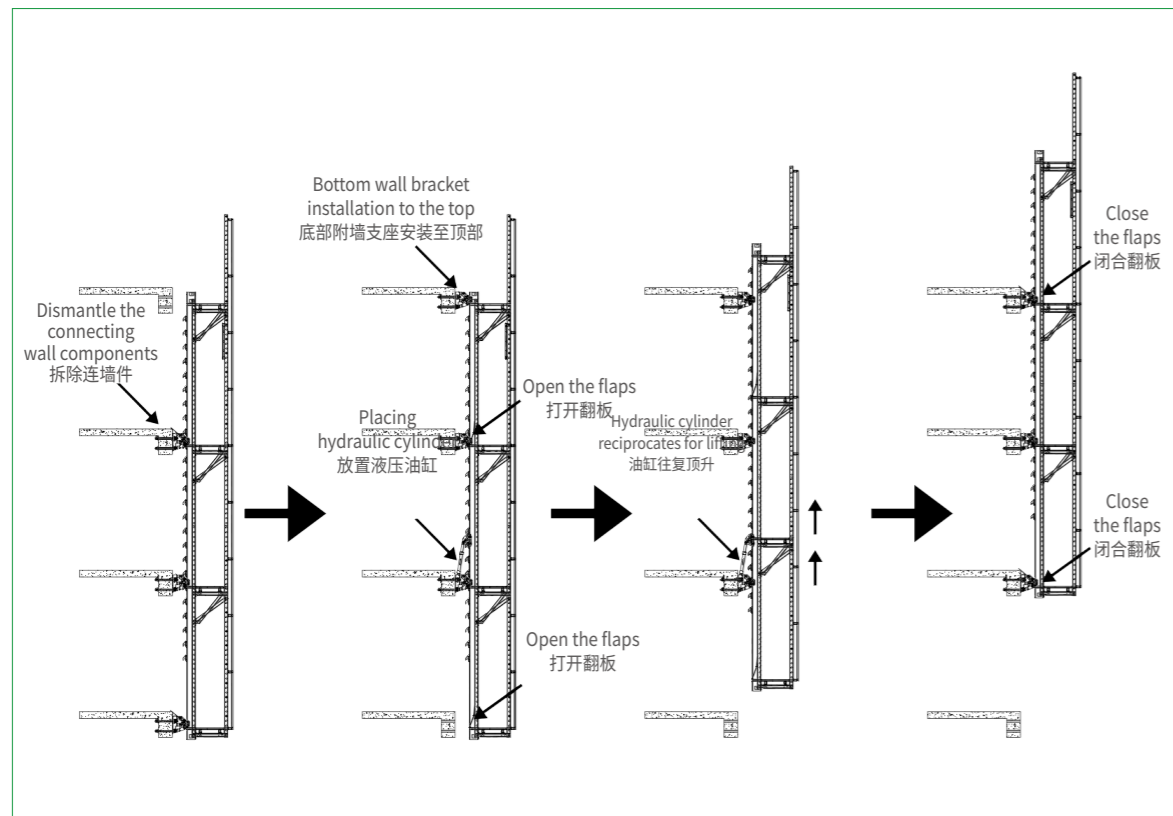

**Note:** Tower crane can be used to lift the protection screen.

**注意:** 可以采用塔吊提升防护屏。

# TECHNICAL SOLUTIONS

## 特殊位置处理方式

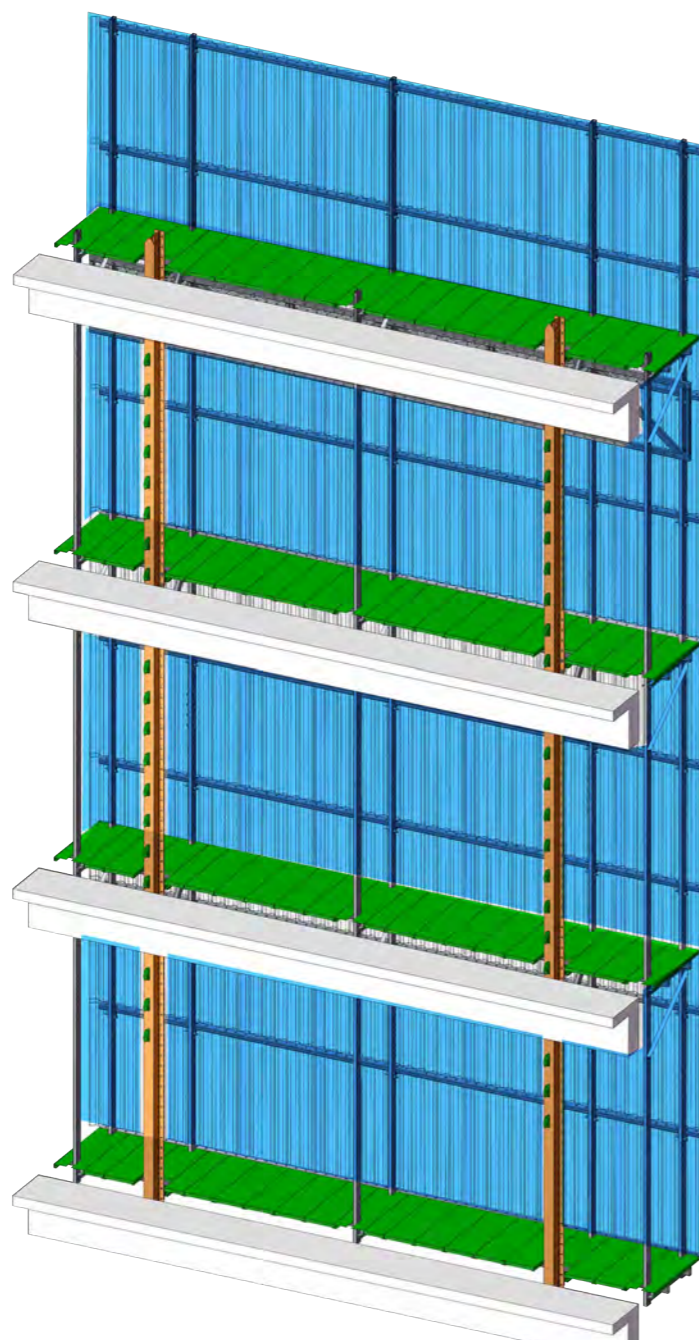

### -The framework structure at the location of the tower crane attached arm.

#### 塔吊附臂位置处架体构造

Higher framework to avoid interference with the tower crane attached arm.  
较高架体避免干涉塔吊附臂

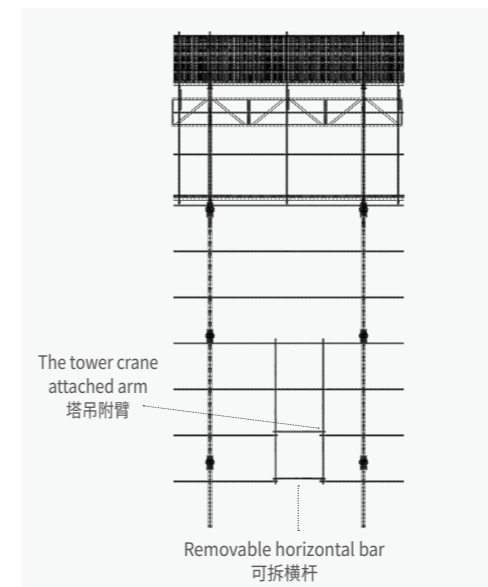

Lower framework to avoid interference with the tower crane attached arm.  
较矮架体避免干涉塔吊附臂

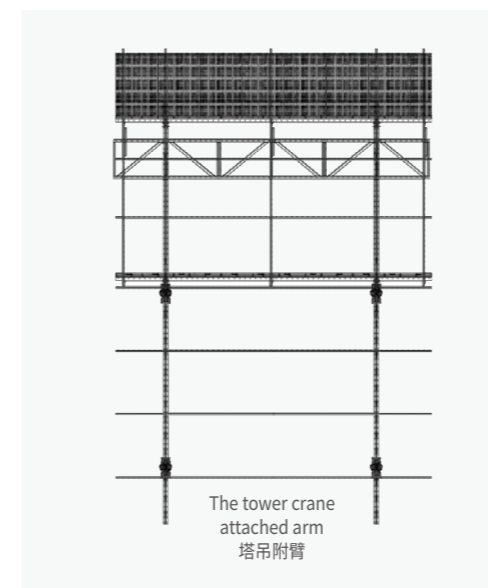

-The framework structure at the location of the construction elevator.  
施工电梯位置处架体构造



**Note:** Protection screen covers the main structure up to 2.5 levels, avoiding construction elevator enter.  
**注意:** 防护屏覆盖主体结构 2.5 层的, 不建议施工电梯进入架体。

-The framework structure at the location of the loading platform.  
卸料平台位置处架体构造

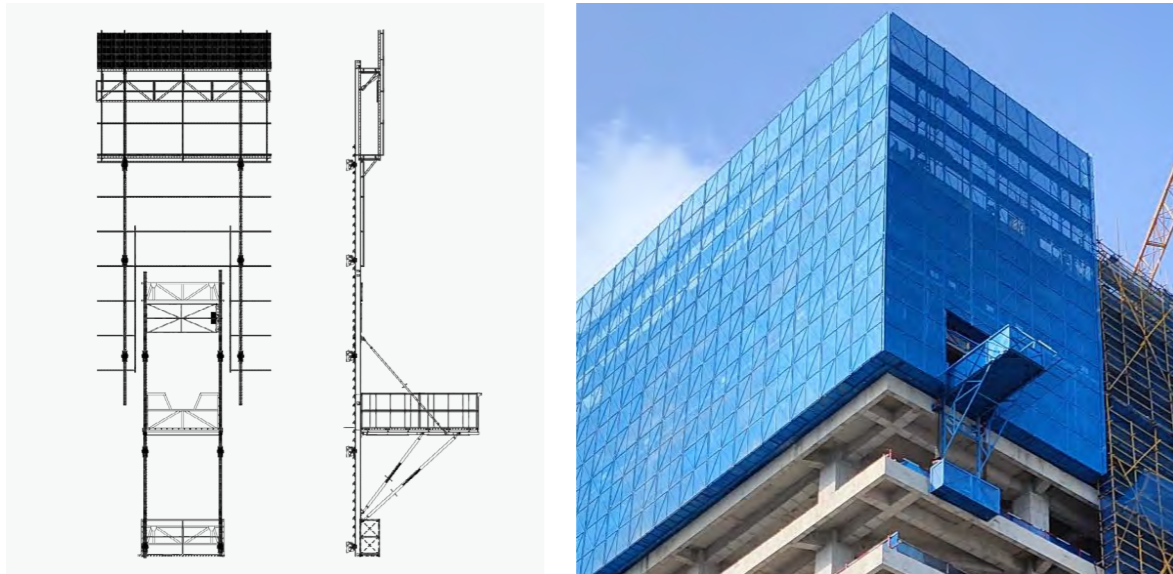

-The bay window utilizes elevated components with inclined tension attachment.  
飘窗位置采用加高件斜拉附着

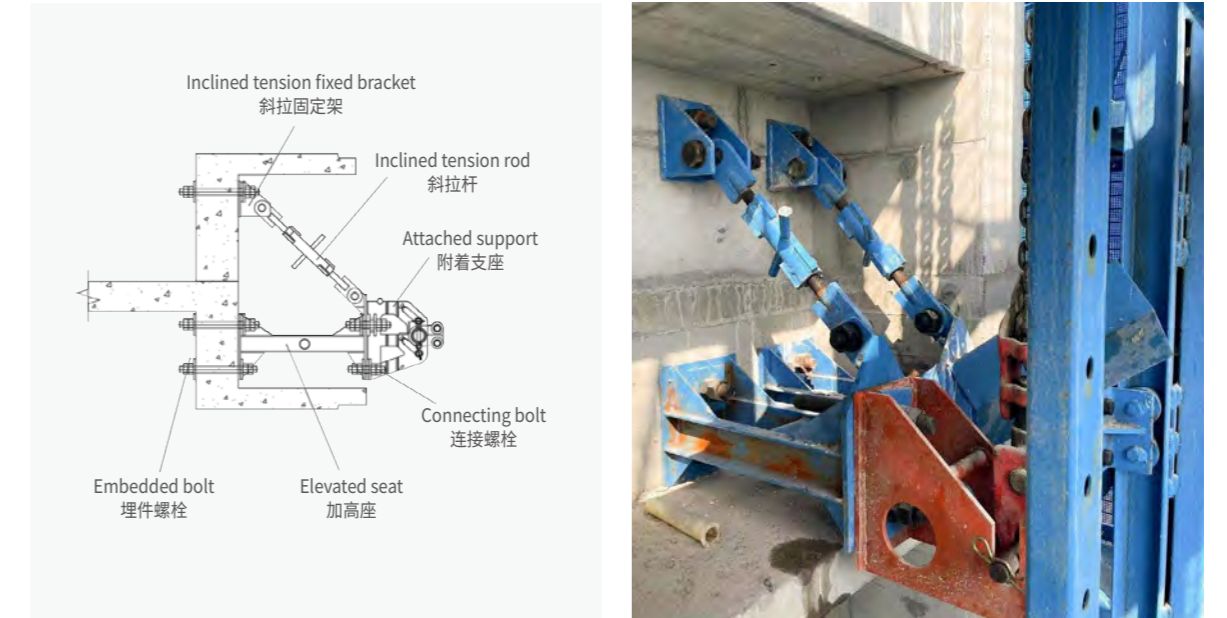

-Floor inclined tension attachment  
楼板面斜拉附着

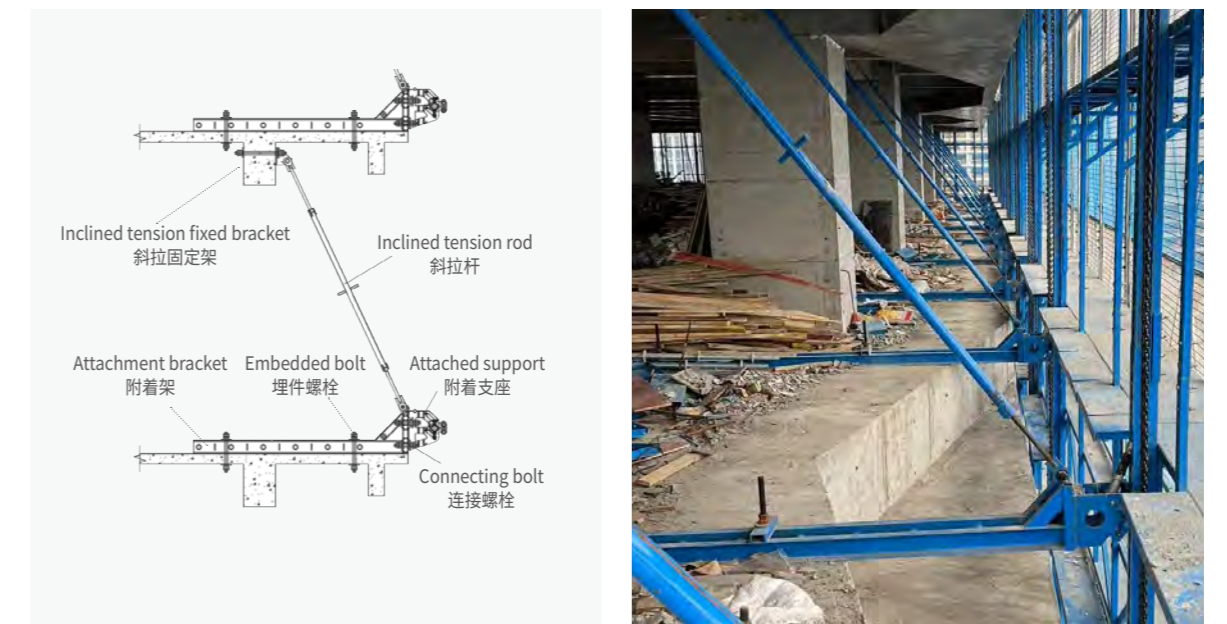



**-Floor with elevated inclined tension attachment**  
楼板面垫高斜拉附着

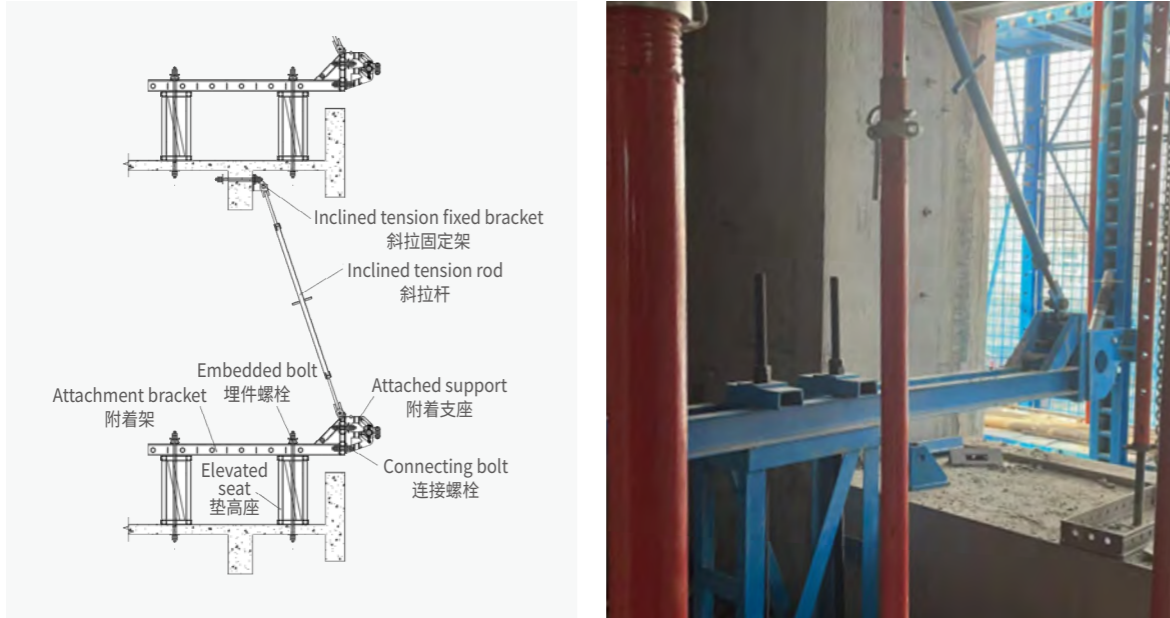

**-At the location of large steel columns in steel structure projects, hoop attachments are installed.**  
钢结构项目大钢柱处设置抱箍附着

Preventing penetration of large steel columns, using hoops for attachment.  
巨大钢柱不允许穿透，采用抱箍实现附着。

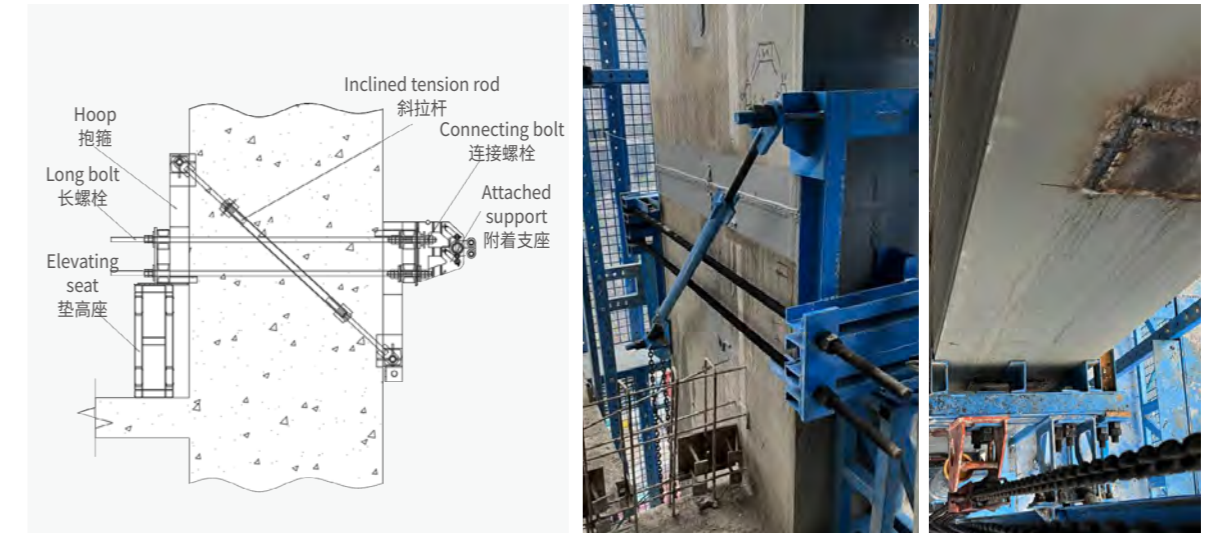

**-Structure overhead or internally retracts and embeds with steel columns attachment.**  
结构架空或内缩内置采用钢构柱附着

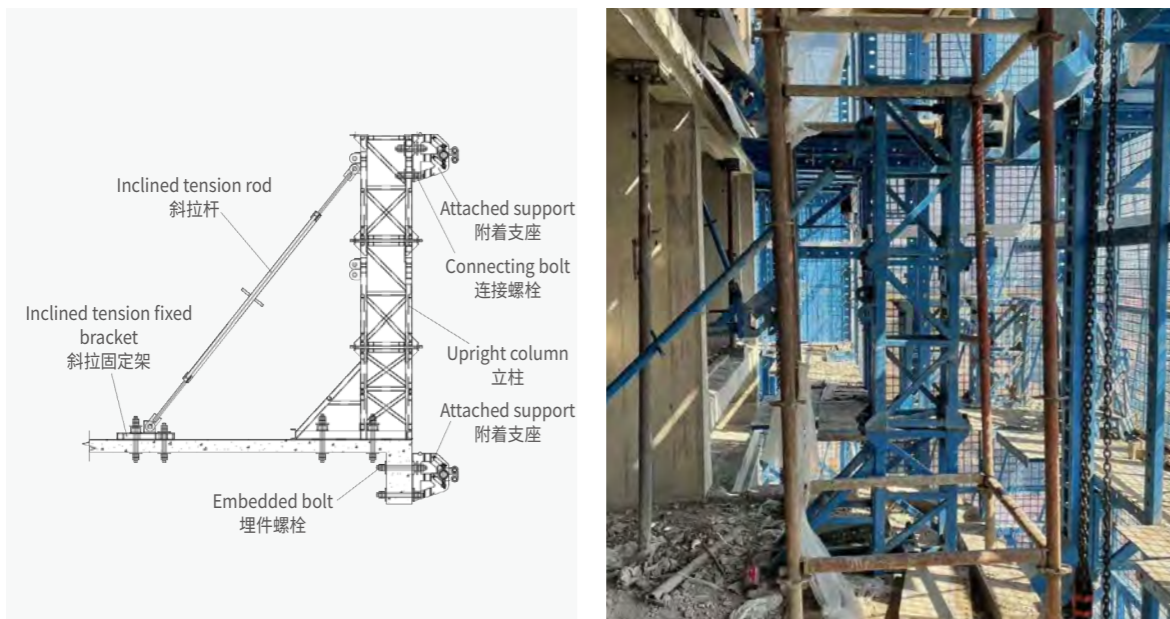

**-Knotting measure for top cantilever of the structure**  
架体顶部悬臂拉结措施

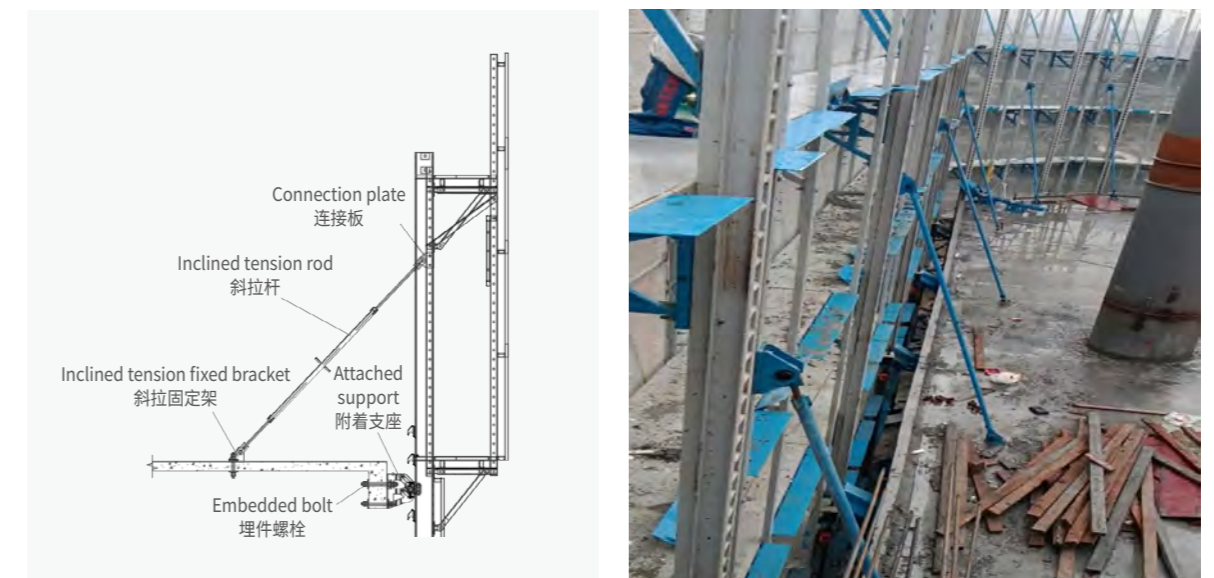

## -Attachment of the inclined facade 倾斜外立面的附着措施

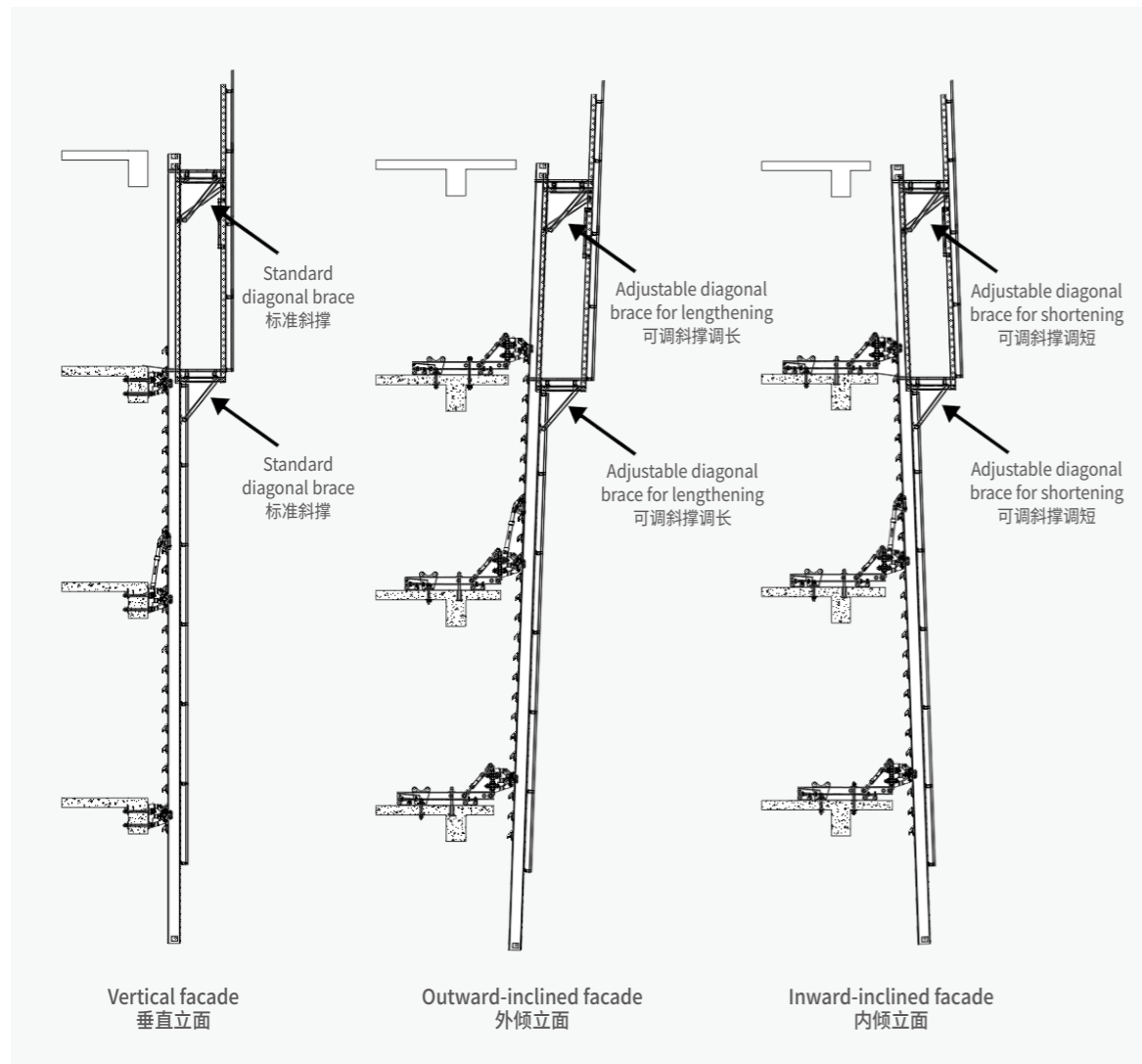

# GETO Group

**Headquarters:**

Greater Bay Area—No. 13 Heqing Road, Tsuihang New District, Zhongshan City, Guangdong Province

**Southern China Production Base I :**

Cuishan Lake Science and Technology Park, Kaiping, Jiangmen City ,Guangdong Province

**Southern China Production Base II :**

Huizhou Industrial Transfer Industrial Park, Huizhou City, Guangdong Province

**Eastern China Production Base I :**

Guangchang Industrial Park, Fuzhou City, Jiangxi Province

**Eastern China Production Base II :**

Baizhong Industrial Park, Minqing , Fuzhou City, Fujian Province

**Central China Production Base:**

Hi-tech Industry Development Zone, Xianning City, Hubei Province

**Southwest China Production Base:**

Modern Manufacturing Industrial Park, Tongnan High-Tech District, Chongqing City

**Northwest China Production Base:**

The Circular Economy Park, Anding District, Dingxi City, Gansu Province

**Hainan Production Base:**

Gold Medal Port Industrial Park, Lingao County, Hainan Province

**ASEAN Production Base:**

Negeri Sembilan, Malaysia

**Singapore Production Base :**

West Region, Singapore

---

## Contact

**Sales Hotline:** 0086-760-88589004

**E-mail:** [geto\\_market@geto.com.cn](mailto:geto_market@geto.com.cn)

**Website:** [www.getoformwork.com](http://www.getoformwork.com)

20240625V1

